

Canal équipé

Canaux équipés

Code: 3026 800



CARACTÉRISTIQUES

ÉVIERS PROFONDS

Acier de 1 mm d'épaisseur. Une épaisseur importante qui garantit une résistance maximale pour les éviers qui ne connaissent pas les signes du temps.

DÉTAILS

Bord d'installation

A fleur | FTS

Matériau

Acier inoxydable AISI 304

Finition

Brossée Foster

Textures

Satiné

Base

120 cm

Dimensions extérieures

1150 x 170 mm

Dimensions intérieures

1122 x 142 mm

Largeur 115 cm

Longueur 8 unité - Standard

Trou d'encastrement Voir fiche technique

Équipement standard Crochets de fixation, joint, vidange, emballage en boîte

Vidange Vidange de 1¼"

Clé de lecture pour les accessoires Les longueurs des canaux et des accessoires sont indiquées en "unités". Pour la composition, la somme des "unités" des accessoires doit correspondre à la longueur en "unités" du canal.

DESSINS TECHNIQUES

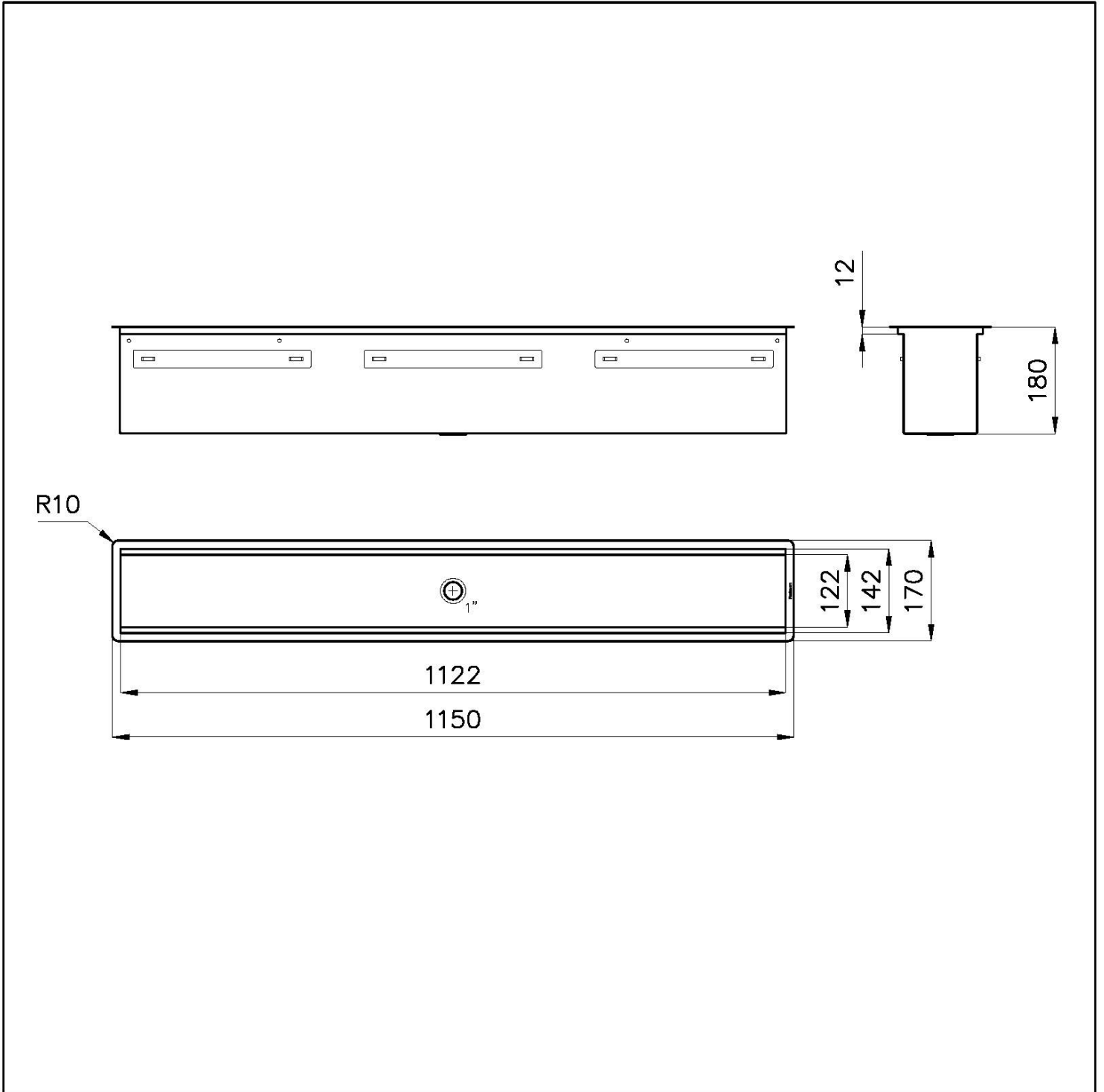

Filotop/Flush-mount

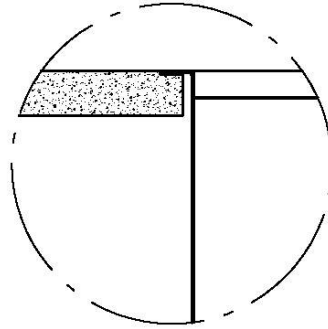

B-B:
Dettaglio installazione
Installation detail

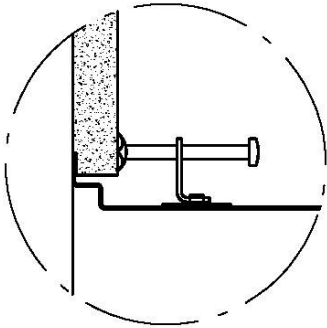

A-A:
Dettaglio installazione e sistema di fissaggio
Installation detail and fixing system

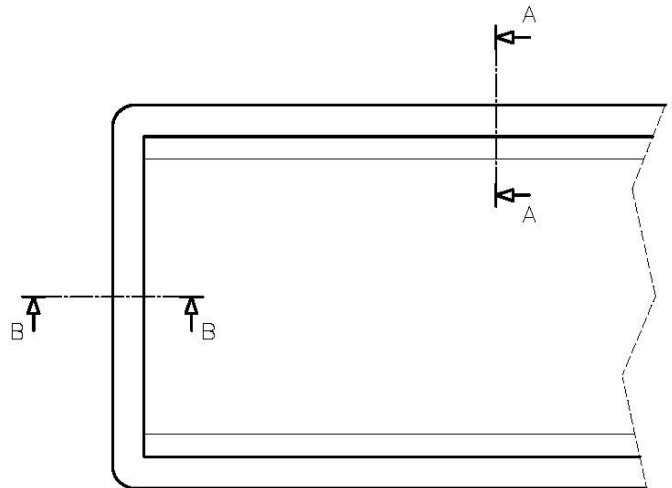

Dimensioni per foratura top
Cut out size

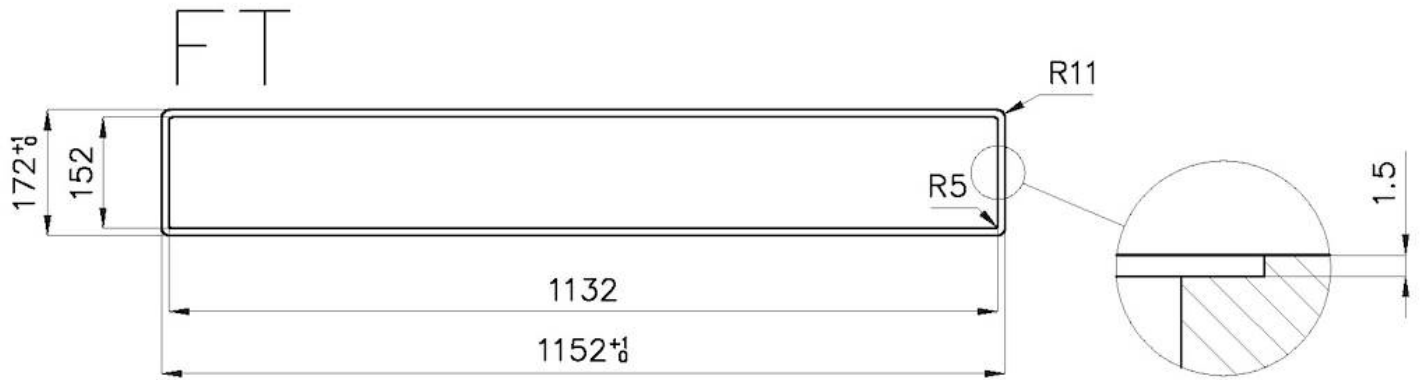

GALERIE

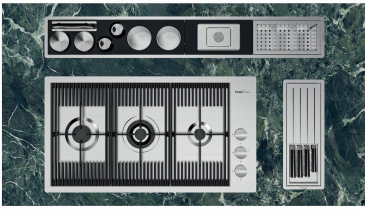

ACCESSOIRES OPTIONNELS



Cuvette perforée en acier inoxydable
8151 003



Kit "A"
8100 703



Kit "B"
8100 700



Kit "C"
8100 701



Kit "D"
8100 704



Kit "E"
8100 705



Kit "F"
8100 706



Kit "G"
8100 710



Kit "H"
8100 702



Kit "N"
8100 714



Porte-assiettes inox
1773 100



Porte-prises en acier inoxydable
8000 020



Stainless steel knife holder
8100 712